

Kanlux



KANLUX
ALIN LED LINE
V novom
tvare

Kanlux
FΔCTORY
kanlux.com

KANLUX ALIN LED LINE

Ešte viac možností

Rozšírenie ponuky
Kanlux ALIN LED LINE
o nové elementy
v podobe spojok
a tvaroviek umožňuje
realizácie netradičných
projektov.

Teraz záleží na tvare.
Vytvára individuálny
charakter investície.

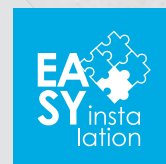
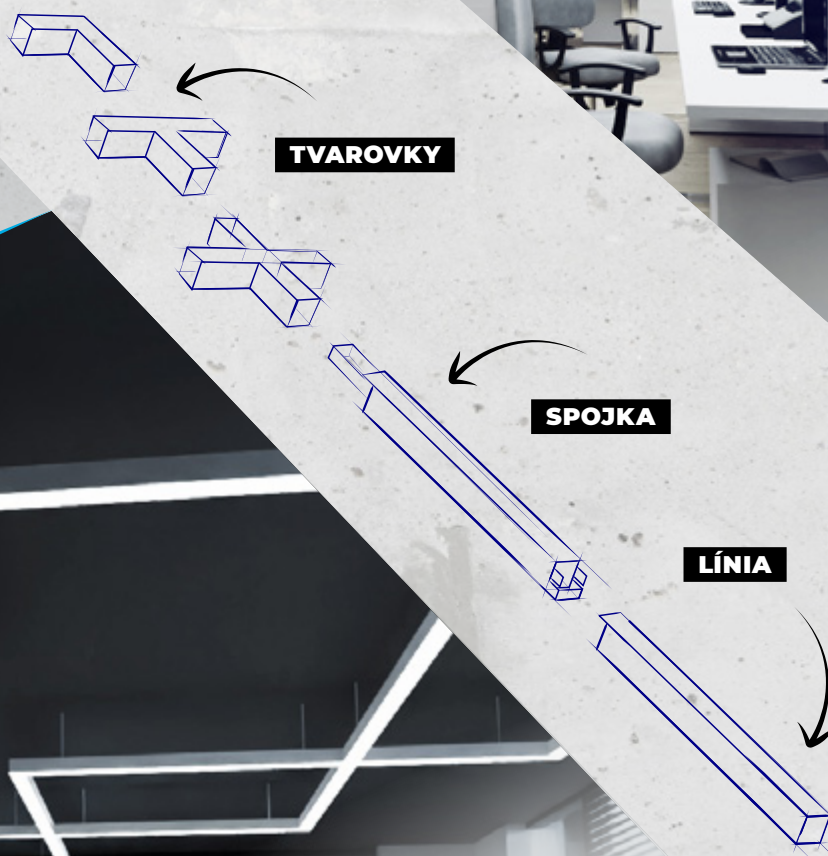

KANLUX ALIN LED LINE

Vytvárajte línie a štruktúry na mieru Vaším potrebám.

Neopakovateľný efekt, ešte viac využitia.

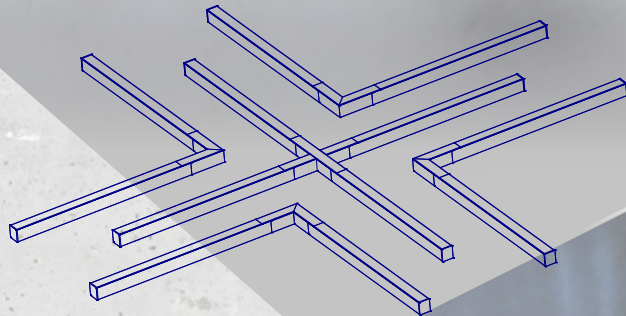

ALIN LED LINE elementy rovnej línie

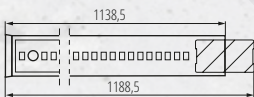

línia **LF**

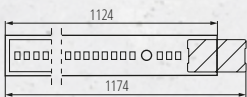

línia **LM**

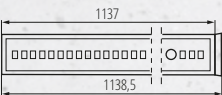

línia **LL**

TVAROVKY pasívne spojovacie elementy

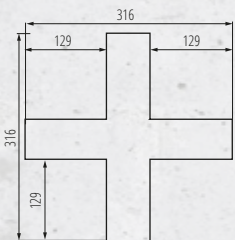

tvár **X**

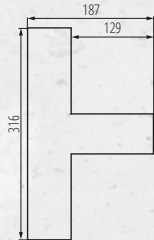

tvár **T**

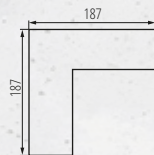

tvár **L**

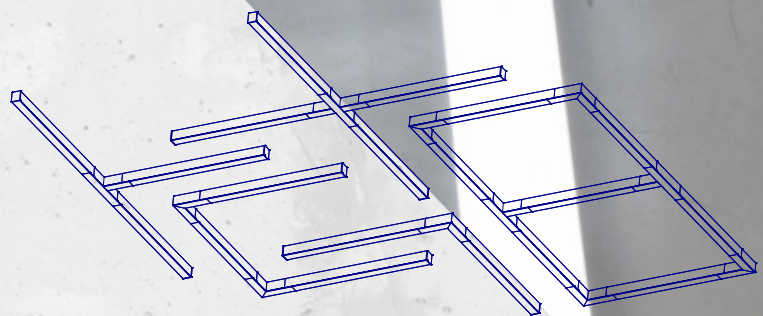

tvárovka **T** + spojka **LTX1** + línia **LM**



SPOJKY aktívne spojovacie elementy

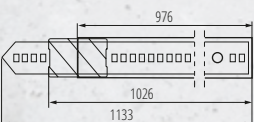

spojka **LTX1**

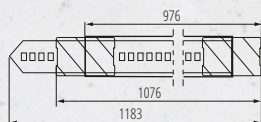

spojka **LTX1C**

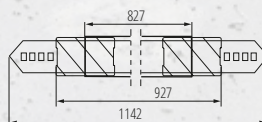

spojka **LTX2C**

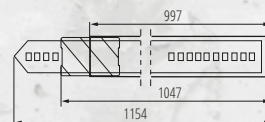

spojka **LTX1E**

KANLUX ALIN LED LINE

Tvarovky a spojky
perfektné dopĺňajú
líniový systém ALIN.

Sú k dispozícii v niekoľkých
typoch, podobne ako farba
a typ difúzora svietidiel.
Dostupné je aj prevedenie
podporujúce ovládanie DALI.

TRI DRUHY TVAROV	TRI FARBY KORPUSU
DVA TYPY DIFÚZOROV	VOLITEL'NÉ PREVEDENIE V SÚLADE S DALI

VÝZNAM PÍSMEN V NÁZVE

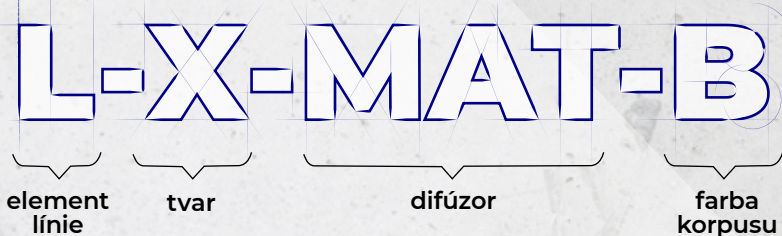

35010 L-X-MAT-B

35011 L-X-MAT-S

35012 L-X-MAT-W

35018 L-X-MPR-B

35019 L-X-MPR-S

35020 L-X-MPR-W

35171 LD-X-MAT-B

35172 LD-X-MAT-S

35173 LD-X-MAT-W

35180 LD-X-MPR-B

35181 LD-X-MPR-S

35182 LD-X-MPR-W

35013 L-T-MAT-B

35014 L-T-MAT-S

35015 L-T-MAT-W

35021 L-T-MPR-B

35022 L-T-MPR-S

35023 L-T-MPR-W

35174 LD-T-MAT-B

35175 LD-T-MAT-S

35176 LD-T-MAT-W

35183 LD-T-MPR-B

35184 LD-T-MPR-S

35185 LD-T-MPR-W

35016 L-L-MAT-B

35017 L-L-MAT-S

34405 L-L-MAT-W

35024 L-L-MPR-B

35025 L-L-MPR-S

35026 L-L-MPR-W

35177 LD-L-MAT-B

35178 LD-L-MAT-S

35179 LD-L-MAT-W

35186 LD-L-MPR-B

35187 LD-L-MPR-S

35188 LD-L-MPR-W

▼ LEGENDA

L-X	tvarovka typu X
LD-X	tvarovka DALI typu X
L-L	tvarovka typu L
LD-L	tvarovka DALI typu L
L-T	tvarovka typu T
LD-T	tvarovka DALI typu T

KANLUX ALIN LED LINE

Tvarovky a **spojky** perfektne dopĺňajú líniový systém ALIN.

Široká rôznorodosť spojok a tvaroviek dovoľuje vybudovať jednoduché svetelné línie do kompletných svetelných systémov zložitých štruktúr.

ŠTYRI VERZIE RÔZNYCH SPOJOK

+ DVE ŠTANDARDNÉ TEPLoty CHROMATICKOSTI

+ UNIVERZÁLNE PREVEDENIE UMOŽŇUJÚCE MONTÁŽ NA STROP ALEBO ZAVESENIE

▼ LEGENDA (podľa smeru budovania línie)

LTX1	spojka LED: línia → tvarovka
LTX1C	spojka LED: tvarovka → línia
LTX2C	spojka LED tvarovka → tvarovka
LTX1E	ukončovací LED element línie za tvarovkou

VÝZNAM PÍSMEN V NÁZVE

LM-LTX1-ML-NW-MAT-B

element línie

spojka LED

dĺžka, výkon

farba svetla

difúzor

farba korpusu

LTX1

LTX2C

LTX1C

LTX1E

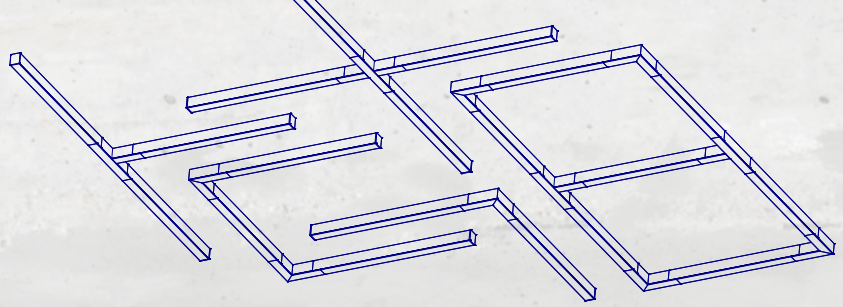

LTX1

35027	LM-LTX1-ML-NW-MAT-B
35028	LM-LTX1-ML-NW-MAT-S
35029	LM-LTX1-ML-NW-MAT-W
35030	LM-LTX1-MM-NW-MAT-B
35031	LM-LTX1-MM-NW-MAT-S
35032	LM-LTX1-MM-NW-MAT-W
35033	LM-LTX1-ML-WW-MAT-B
35034	LM-LTX1-ML-WW-MAT-S
35035	LM-LTX1-ML-WW-MAT-W
35036	LM-LTX1-MM-WW-MAT-B
35037	LM-LTX1-MM-WW-MAT-S
35038	LM-LTX1-MM-WW-MAT-W
35039	LM-LTX1-ML-NW-MPR-B
35040	LM-LTX1-ML-NW-MPR-S
35041	LM-LTX1-ML-NW-MPR-W
35042	LM-LTX1-MM-NW-MPR-B
35043	LM-LTX1-MM-NW-MPR-S
35044	LM-LTX1-MM-NW-MPR-W
35045	LM-LTX1-ML-WW-MPR-B
35046	LM-LTX1-ML-WW-MPR-S
35047	LM-LTX1-ML-WW-MPR-W
35048	LM-LTX1-MM-WW-MPR-B
35049	LM-LTX1-MM-WW-MPR-S
35050	LM-LTX1-MM-WW-MPR-W
35099	LMD-LTX1-ML-NW-MAT-B
35100	LMD-LTX1-ML-NW-MAT-S
35101	LMD-LTX1-ML-NW-MAT-W
35102	LMD-LTX1-MM-NW-MAT-B
35103	LMD-LTX1-MM-NW-MAT-S
35104	LMD-LTX1-MM-NW-MAT-W
35105	LMD-LTX1-ML-WW-MAT-B
35106	LMD-LTX1-ML-WW-MAT-S
35107	LMD-LTX1-ML-WW-MAT-W
35108	LMD-LTX1-MM-WW-MAT-B
35109	LMD-LTX1-MM-WW-MAT-S
35110	LMD-LTX1-MM-WW-MAT-W
35111	LMD-LTX1-ML-NW-MPR-B
35112	LMD-LTX1-ML-NW-MPR-S
35113	LMD-LTX1-ML-NW-MPR-W
35114	LMD-LTX1-MM-NW-MPR-B
35115	LMD-LTX1-MM-NW-MPR-S
35116	LMD-LTX1-MM-NW-MPR-W
35117	LMD-LTX1-ML-WW-MPR-B
35118	LMD-LTX1-ML-WW-MPR-S
35119	LMD-LTX1-ML-WW-MPR-W
35120	LMD-LTX1-MM-WW-MPR-B
35121	LMD-LTX1-MM-WW-MPR-S
35122	LMD-LTX1-MM-WW-MPR-W

LTX1C

35051	LM-LTX1C-ML-NW-MAT-B
35052	LM-LTX1C-ML-NW-MAT-S
35053	LM-LTX1C-ML-NW-MAT-W
35054	LM-LTX1C-MM-NW-MAT-B
35055	LM-LTX1C-MM-NW-MAT-S
35056	LM-LTX1C-MM-NW-MAT-W
35057	LM-LTX1C-ML-WW-MAT-B
35058	LM-LTX1C-ML-WW-MAT-S
35059	LM-LTX1C-ML-WW-MAT-W
35060	LM-LTX1C-MM-WW-MAT-B
35061	LM-LTX1C-MM-WW-MAT-S
35062	LM-LTX1C-MM-WW-MAT-W
35063	LM-LTX1C-ML-NW-MPR-B
35064	LM-LTX1C-ML-NW-MPR-S
35065	LM-LTX1C-ML-NW-MPR-W
35066	LM-LTX1C-MM-NW-MPR-B
35067	LM-LTX1C-MM-NW-MPR-S
35068	LM-LTX1C-MM-NW-MPR-W
35069	LM-LTX1C-ML-WW-MPR-B
35070	LM-LTX1C-ML-WW-MPR-S
35071	LM-LTX1C-ML-WW-MPR-W
35072	LM-LTX1C-MM-WW-MPR-B
35073	LM-LTX1C-MM-WW-MPR-S
35074	LM-LTX1C-MM-WW-MPR-W
35123	LMD-LTX1C-ML-NW-MAT-B
35124	LMD-LTX1C-ML-NW-MAT-S
35125	LMD-LTX1C-ML-NW-MAT-W
35126	LMD-LTX1C-MM-NW-MAT-B
35127	LMD-LTX1C-MM-NW-MAT-S
35128	LMD-LTX1C-MM-NW-MAT-W
35129	LMD-LTX1C-ML-WW-MAT-B
35130	LMD-LTX1C-ML-WW-MAT-S
35131	LMD-LTX1C-ML-WW-MAT-W
35132	LMD-LTX1C-MM-WW-MAT-B
35133	LMD-LTX1C-MM-WW-MAT-S
35134	LMD-LTX1C-MM-WW-MAT-W
35135	LMD-LTX1C-ML-NW-MPR-B
35136	LMD-LTX1C-ML-NW-MPR-S
35137	LMD-LTX1C-ML-NW-MPR-W
35138	LMD-LTX1C-MM-NW-MPR-B
35139	LMD-LTX1C-MM-NW-MPR-S
35140	LMD-LTX1C-MM-NW-MPR-W
35141	LMD-LTX1C-ML-WW-MPR-B
35142	LMD-LTX1C-ML-WW-MPR-S
35143	LMD-LTX1C-ML-WW-MPR-W
35144	LMD-LTX1C-MM-WW-MPR-B
35145	LMD-LTX1C-MM-WW-MPR-S
35146	LMD-LTX1C-MM-WW-MPR-W

LTX2C

35075	LM-LTX2C-ML-NW-MAT-B
35076	LM-LTX2C-ML-NW-MAT-S
35077	LM-LTX2C-ML-NW-MAT-W
35078	LM-LTX2C-MM-NW-MAT-B
35079	LM-LTX2C-MM-NW-MAT-S
35080	LM-LTX2C-MM-NW-MAT-W
35081	LM-LTX2C-ML-WW-MAT-B
35082	LM-LTX2C-ML-WW-MAT-S
35083	LM-LTX2C-ML-WW-MAT-W
35084	LM-LTX2C-MM-WW-MAT-B
35085	LM-LTX2C-MM-WW-MAT-S
35086	LM-LTX2C-MM-WW-MAT-W
35087	LM-LTX2C-ML-NW-MPR-B
35088	LM-LTX2C-ML-NW-MPR-S
35089	LM-LTX2C-ML-NW-MPR-W
35090	LM-LTX2C-MM-NW-MPR-B
35091	LM-LTX2C-MM-NW-MPR-S
35092	LM-LTX2C-MM-NW-MPR-W
35093	LM-LTX2C-ML-WW-MPR-B
35094	LM-LTX2C-ML-WW-MPR-S
35095	LM-LTX2C-ML-WW-MPR-W
35096	LM-LTX2C-MM-WW-MPR-B
35097	LM-LTX2C-MM-WW-MPR-S
35098	LM-LTX2C-MM-WW-MPR-W
35147	LMD-LTX2C-ML-NW-MAT-B
35148	LMD-LTX2C-ML-NW-MAT-S
35149	LMD-LTX2C-ML-NW-MAT-W
35150	LMD-LTX2C-MM-NW-MAT-B
35151	LMD-LTX2C-MM-NW-MAT-S
35152	LMD-LTX2C-MM-NW-MAT-W
35153	LMD-LTX2C-ML-WW-MAT-B
35154	LMD-LTX2C-ML-WW-MAT-S
35155	LMD-LTX2C-ML-WW-MAT-W
35156	LMD-LTX2C-MM-WW-MAT-B
35157	LMD-LTX2C-MM-WW-MAT-S
35158	LMD-LTX2C-MM-WW-MAT-W
35159	LMD-LTX2C-ML-NW-MPR-B
35160	LMD-LTX2C-ML-NW-MPR-S
35161	LMD-LTX2C-ML-NW-MPR-W
35162	LMD-LTX2C-MM-NW-MPR-B
35163	LMD-LTX2C-MM-NW-MPR-S
35164	LMD-LTX2C-MM-NW-MPR-W
35165	LMD-LTX2C-ML-WW-MPR-B
35166	LMD-LTX2C-ML-WW-MPR-S
35167	LMD-LTX2C-ML-WW-MPR-W
35168	LMD-LTX2C-MM-WW-MPR-B
35169	LMD-LTX2C-MM-WW-MPR-S
35170	LMD-LTX2C-MM-WW-MPR-W

LTX1E

35189	LL-LTX1E-ML-NW-MAT-B
35190	LL-LTX1E-ML-NW-MAT-S
35191	LL-LTX1E-ML-NW-MAT-W
35192	LL-LTX1E-MM-NW-MAT-B
35193	LL-LTX1E-MM-NW-MAT-S
35194	LL-LTX1E-MM-NW-MAT-W
35195	LL-LTX1E-ML-WW-MAT-B
35196	LL-LTX1E-ML-WW-MAT-S
35197	LL-LTX1E-ML-WW-MAT-W
35198	LL-LTX1E-MM-WW-MAT-B
35199	LL-LTX1E-MM-WW-MAT-S
35200	LL-LTX1E-MM-WW-MAT-W
35201	LL-LTX1E-ML-NW-MPR-B
35202	LL-LTX1E-ML-NW-MPR-S
35203	LL-LTX1E-ML-NW-MPR-W
35204	LL-LTX1E-MM-NW-MPR-B
35205	LL-LTX1E-MM-NW-MPR-S
35206	LL-LTX1E-MM-NW-MPR-W
35207	LL-LTX1E-ML-WW-MPR-B
35208	LL-LTX1E-ML-WW-MPR-S
35209	LL-LTX1E-ML-WW-MPR-W
35210	LL-LTX1E-MM-WW-MPR-B
35211	LL-LTX1E-MM-WW-MPR-S
35212	LL-LTX1E-MM-WW-MPR-W
35213	LLD-LTX1E-ML-NW-MAT-B
35214	LLD-LTX1E-ML-NW-MAT-S
35215	LLD-LTX1E-ML-NW-MAT-W
35216	LLD-LTX1E-MM-NW-MAT-B
35217	LLD-LTX1E-MM-NW-MAT-S
35218	LLD-LTX1E-MM-NW-MAT-W
35219	LLD-LTX1E-ML-WW-MAT-B
35220	LLD-LTX1E-ML-WW-MAT-S
35221	LLD-LTX1E-ML-WW-MAT-W
35222	LLD-LTX1E-MM-WW-MAT-B
35223	LLD-LTX1E-MM-WW-MAT-S
35224	LLD-LTX1E-MM-WW-MAT-W
35225	LLD-LTX1E-ML-NW-MPR-B
35226	LLD-LTX1E-ML-NW-MPR-S
35227	LLD-LTX1E-ML-NW-MPR-W
35228	LLD-LTX1E-MM-NW-MPR-B
35229	LLD-LTX1E-MM-NW-MPR-S
35230	LLD-LTX1E-MM-NW-MPR-W
35231	LLD-LTX1E-ML-WW-MPR-B
35232	LLD-LTX1E-ML-WW-MPR-S
35233	LLD-LTX1E-ML-WW-MPR-W
35234	LLD-LTX1E-MM-WW-MPR-B
35235	LLD-LTX1E-MM-WW-MPR-S
35236	LLD-LTX1E-MM-WW-MPR-W

KANLUX ALIN LED LINE

Líniový systém ALIN je inovatívny systém osvetlenia s veľkými možnosťami prispôsobenia potrebám každej investície.

Kanlux ALIN LED LINE umožňuje vytvorenie dlhých svetelných línií s jednoduchými alebo neštandardnými tvarmi.



prisadená verzia



nástenná verzia
= prisadená verzia + ALIN NT GRIP



závesná verzia = prisadená verzia
+ ALIN CORD + ROPE (napájací
prívod, ocelové lanko na zavesenie)



2 farby svetla
+ možnosť prevedenia
TUNABLE WHITE

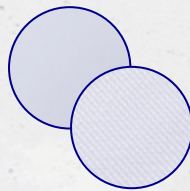

dva typy
difúzora: matný
a mikroprizmatický



ľubovoľná personalizácia
výberu farby
korpusu: biela,
strieborná, čierna



možnosť zabudovať
mikrovlnné
čidlo pohybu



možnosť
prevedenia
v súlade s DALI

UNIVERZÁLNE PREVEDENIE
UMOŽŇUJÚCE AKO ZÁVESNÚ
TAK AJ PRISADENÚ MONTÁŽ

DVE FARBY SVETLA

DVA TYPY DIFÚZORA

TRI FARBY KORPUSU

MOŽNOSŤ PREVEDENIA
KOMPATIBILNÉ S DALI

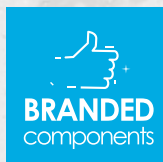

KANLUX ALIN LED LINE

LíniaLED sa skladá z nasledujúcich elementov:

- počiatočný element LF
- ľubovoľný počet stredných elementov LM
- koncový element LL



LEGENDA ▶

LF	1137mm počiatočný element
LM	1124mm stredný element
LL	1137mm počiatočný element
LFD	1137mm stredný element DALI
LMD	1124mm stredný element DALI
LLD	1137mm koncový element DALI
ML	nízky výkon
MM	stredný výkon
WW	3000K Ra ≥ 80
NW	4000K Ra ≥ 80
TW	tunable white
MAT	matný difúzor
MPR	mikroprizmatický difúzor
W	farba korpusu: biela
B	farba korpusu: čierna
S	farba korpusu: strieborná
NT	prísadená verzia
ALIN +CORD +ROPE	závesná verzia
L-X	tvarovka typu X
LD-X	tvarovka DALI typu X
L-L	tvarovka typu L
LD-L	tvarovka DALI typu L
L-T	tvarovka typu T
LD-T	tvarovka DALI typu T
LTX1	spojka LED: línia → tvarovka
LTX1C	spojka LED: tvarovka → línia
LTX2C	spojka LED tvarovka → tvarovka
LTXIE	LED element končiaci líniu za tvarovkou



Svetelný tok a výkon svetiel Kanlux ALIN LED

		svetelný tok			
		difúzor MAT		difúzor MPR	
	výkon	830	840	830	840
ML	25W	2980lm	3250lm	2750lm	3000lm
MM	29W	3450lm	3900lm	3170lm	3600lm

up to
140 $\frac{\text{lm}}{\text{W}}$



KANLUX ALIN LED LINE

VÝZNAM PÍSMEN V NÁZVE

LF-ML-NW-MAT-B-NT

element
linie

dĺžka
výkon

farba
svetla

difúzor

farba
korpusu

spôsob
montáže

LF / LFD

34528 LF-ML-NW-MAT-B-NT
34529 LF-ML-NW-MAT-S-NT
34530 LF-ML-NW-MAT-W-NT
34531 LF-ML-NW-MPR-B-NT
34532 LF-ML-NW-MPR-S-NT
34533 LF-ML-NW-MPR-W-NT
34534 LF-ML-WW-MAT-B-NT
34535 LF-ML-WW-MAT-S-NT
34536 LF-ML-WW-MAT-W-NT
34537 LF-ML-WW-MPR-B-NT
34538 LF-ML-WW-MPR-S-NT
34539 LF-ML-WW-MPR-W-NT
34540 LF-MM-NW-MAT-B-NT
34541 LF-MM-NW-MAT-S-NT
34542 LF-MM-NW-MAT-W-NT
34543 LF-MM-NW-MPR-B-NT
34544 LF-MM-NW-MPR-S-NT
34545 LF-MM-NW-MPR-W-NT
34546 LF-MM-WW-MAT-B-NT
34547 LF-MM-WW-MAT-S-NT
34548 LF-MM-WW-MAT-W-NT
34549 LF-MM-WW-MPR-B-NT
34550 LF-MM-WW-MPR-S-NT
34551 LF-MM-WW-MPR-W-NT
34552 LFD-ML-NW-MAT-B-NT
34553 LFD-ML-NW-MAT-S-NT
34554 LFD-ML-NW-MAT-W-NT
34555 LFD-ML-NW-MPR-B-NT
34556 LFD-ML-NW-MPR-S-NT
34557 LFD-ML-NW-MPR-W-NT
34558 LFD-ML-WW-MAT-B-NT
34559 LFD-ML-WW-MAT-S-NT
34560 LFD-ML-WW-MAT-W-NT
34561 LFD-ML-WW-MPR-B-NT
34562 LFD-ML-WW-MPR-S-NT
34563 LFD-ML-WW-MPR-W-NT
34564 LFD-MM-NW-MAT-B-NT
34565 LFD-MM-NW-MAT-S-NT
34566 LFD-MM-NW-MAT-W-NT

34567 LFD-MM-NW-MPR-B-NT
34568 LFD-MM-NW-MPR-S-NT
34569 LFD-MM-NW-MPR-W-NT
34570 LFD-MM-WW-MAT-B-NT
34571 LFD-MM-WW-MAT-S-NT
34572 LFD-MM-WW-MAT-W-NT
34573 LFD-MM-WW-MPR-B-NT
34574 LFD-MM-WW-MPR-S-NT

LM / LMD

34672 LM-ML-NW-MAT-B-NT
34673 LM-ML-NW-MAT-S-NT
34674 LM-ML-NW-MAT-W-NT
34675 LM-ML-NW-MPR-B-NT
34676 LM-ML-NW-MPR-S-NT
34677 LM-ML-NW-MPR-W-NT
34678 LM-ML-WW-MAT-B-NT
34679 LM-ML-WW-MAT-S-NT
34680 LM-ML-WW-MAT-W-NT
34681 LM-ML-WW-MPR-B-NT
34682 LM-ML-WW-MPR-S-NT
34683 LM-ML-WW-MPR-W-NT
34684 LM-MM-NW-MAT-B-NT
34685 LM-MM-NW-MAT-S-NT
34686 LM-MM-NW-MAT-W-NT
34687 LM-MM-NW-MPR-B-NT
34688 LM-MM-NW-MPR-S-NT
34689 LM-MM-NW-MPR-W-NT
34690 LM-MM-WW-MAT-B-NT
34691 LM-MM-WW-MAT-S-NT
34692 LM-MM-WW-MAT-W-NT
34693 LM-MM-WW-MPR-B-NT
34694 LM-MM-WW-MPR-S-NT
34695 LM-MM-WW-MPR-W-NT
34696 LMD-ML-NW-MAT-B-NT
34697 LMD-ML-NW-MAT-S-NT
34698 LMD-ML-NW-MAT-W-NT
34699 LMD-ML-NW-MPR-B-NT
34700 LMD-ML-NW-MPR-S-NT
34701 LMD-ML-NW-MPR-W-NT
34702 LMD-ML-WW-MAT-B-NT

34703 LMD-ML-WW-MAT-S-NT
34704 LMD-ML-WW-MAT-W-NT
34705 LMD-ML-WW-MPR-B-NT
34706 LMD-ML-WW-MPR-S-NT
34707 LMD-ML-WW-MPR-W-NT
34708 LMD-MM-NW-MAT-B-NT
34709 LMD-MM-NW-MAT-S-NT
34710 LMD-MM-NW-MAT-W-NT
34711 LMD-MM-NW-MPR-B-NT
34712 LMD-MM-NW-MPR-S-NT
34713 LMD-MM-NW-MPR-W-NT
34714 LMD-MM-WW-MAT-B-NT
34715 LMD-MM-WW-MAT-S-NT
34716 LMD-MM-WW-MAT-W-NT
34717 LMD-MM-WW-MPR-B-NT
34718 LMD-MM-WW-MPR-S-NT
34719 LMD-MM-WW-MPR-W-NT

LL / LLD

34816 LL-ML-NW-MAT-B-NT
34817 LL-ML-NW-MAT-S-NT
34818 LL-ML-NW-MAT-W-NT
34819 LL-ML-NW-MPR-B-NT
34820 LL-ML-NW-MPR-S-NT
34821 LL-ML-NW-MPR-W-NT
34822 LL-ML-WW-MAT-B-NT
34823 LL-ML-WW-MAT-S-NT
34824 LL-ML-WW-MAT-W-NT
34825 LL-ML-WW-MPR-B-NT
34826 LL-ML-WW-MPR-S-NT
34827 LL-ML-WW-MPR-W-NT
34828 LL-MM-NW-MAT-B-NT
34829 LL-MM-NW-MAT-S-NT
34830 LL-MM-NW-MAT-W-NT
34831 LL-MM-NW-MPR-B-NT
34832 LL-MM-NW-MPR-S-NT
34833 LL-MM-NW-MPR-W-NT
34834 LL-MM-WW-MAT-B-NT
34835 LL-MM-WW-MAT-S-NT
34836 LL-MM-WW-MAT-W-NT
34837 LL-MM-WW-MPR-B-NT

34838 LL-MM-WW-MPR-S-NT
34839 LL-MM-WW-MPR-W-NT
34840 LLD-ML-NW-MAT-B-NT
34841 LLD-ML-NW-MAT-S-NT
34842 LLD-ML-NW-MAT-W-NT
34843 LLD-ML-NW-MPR-B-NT
34844 LLD-ML-NW-MPR-S-NT
34845 LLD-ML-NW-MPR-W-NT
34846 LLD-ML-WW-MAT-B-NT
34847 LLD-ML-WW-MAT-S-NT
34848 LLD-ML-WW-MAT-W-NT
34849 LLD-ML-WW-MPR-B-NT
34850 LLD-ML-WW-MPR-S-NT
34851 LLD-ML-WW-MPR-W-NT
34852 LLD-MM-NW-MAT-B-NT
34853 LLD-MM-NW-MAT-S-NT
34854 LLD-MM-NW-MAT-W-NT
34855 LLD-MM-NW-MPR-B-NT
34856 LLD-MM-NW-MPR-S-NT
34857 LLD-MM-NW-MPR-W-NT
34858 LLD-MM-WW-MAT-B-NT
34859 LLD-MM-WW-MAT-S-NT
34860 LLD-MM-WW-MAT-W-NT
34861 LLD-MM-WW-MPR-B-NT
34862 LLD-MM-WW-MPR-S-NT
34863 LLD-MM-WW-MPR-W-NT

PRÍSLUŠENSTVO

Napájacie káble k svietidlám a líniam ALIN, 1 fázové, čierne / strieborné / biele 150 cm

32541 ALIN CORD 1F-B
32542 ALIN CORD 1F-SR
32542 ALIN CORD 1F-W

Napájacie káble k svietidlám a líniam ALIN, 1 fázové DALI, čierne / strieborné / biele 150 cm

32541 ALIN CORD DALI 1F-B
32542 ALIN CORD DALI 1F-SR
32542 ALIN CORD DALI 1F-W

Držiak na stenu pre svietidlo ALIN, 2 ks v balení

29557 ALIN NT GRIP

Ocelové lanko (samostatné) na zavesenie svietidiel, 2 ks v balení

07871 ROPE-NT 150 SINGLE

KANLUX ALIN LED LINE

SCHÉMA ZAPOJENIA

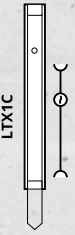
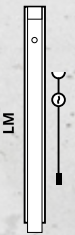
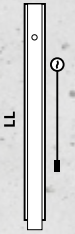
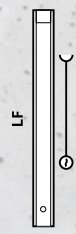
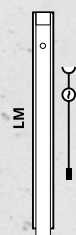
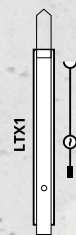
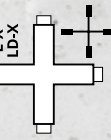
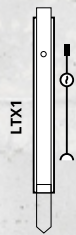
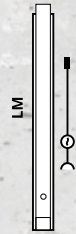
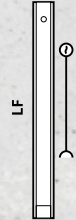
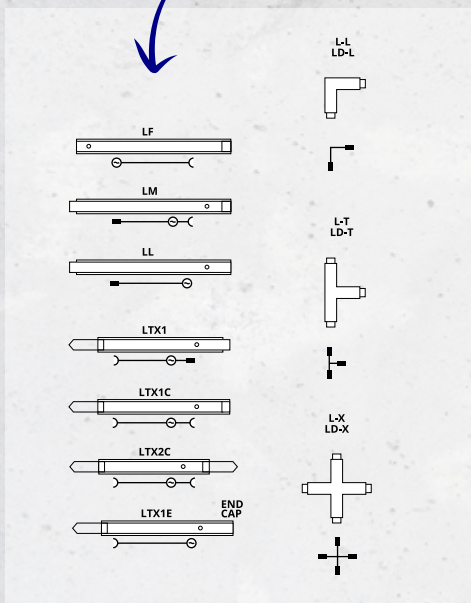
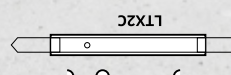
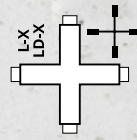
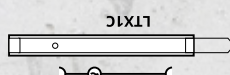
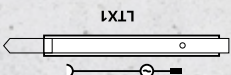
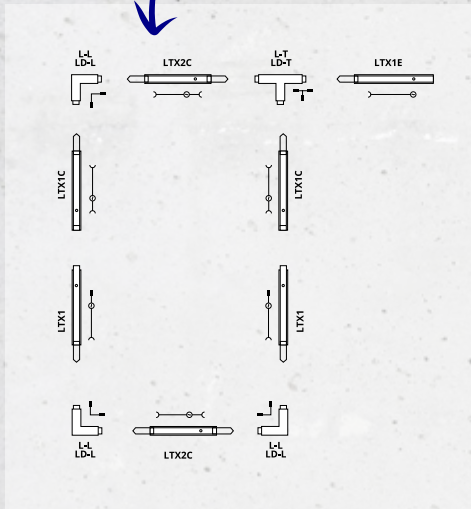
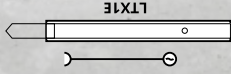
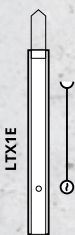
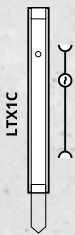
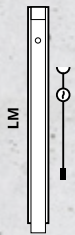
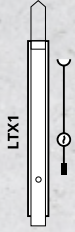
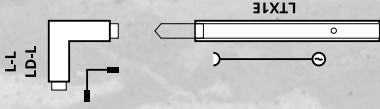

KANLUX ALIN 4LED LINE

Jedinečné riešenie,
ktoré využíva svietidlá
s vymeniteľným
svetelným zdrojom T8 LED
pre vytvorenie módnej
a funkčnej svetelnej línie.

Neobmedzená dĺžka línií, univerzálny dizajn šitý na mieru Vaším požiadavkám a sloboda vo výbere a zmene parametrov svetelného zdroja v každom okamihu využitia, umožňuje vytvoriť výnimočný, na mieru šitý osvetľovací systém.

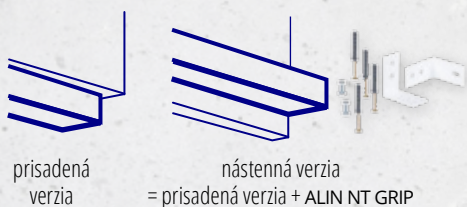

prísadená verzia

nástenná verzia
= prísadená verzia + ALIN NT GRIP



závesná verzia
+ ALIN CORD + ROPE [napájací prívod, oceľové lanko na zavesenie]

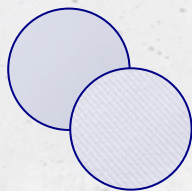

dva typy difúzora: matný a mikroprizmatický



ľubovoľná personalizácia výberu farby korpusu: biela, strieborná, čierna



možnosť zabudovať mikrovlňné čidlo pohybu

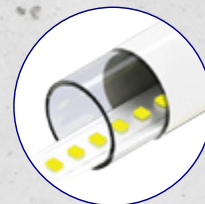

vymeniteľný svetelný zdroj: odporúčané žiarivky T8 GLASSV4

TRI VERZIE MONTÁŽE

DVE FARBY SVETLA

DVA TYPY DIFÚZORA

TRI FARBY KORPUSU

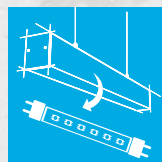

KANLUX ALIN 4LED LINE

Línia 4LED sa skladá z nasledujúcich elementov:

- počiatočný element LF
- ľubovoľný počet stredných elementov LM
- koncový element LL

UNIKÁTNA SVETELNÁ LÍNIA



línia LF

línia LM

línia LL

LEGENDA ►

LF	1364mm počiatočný element
LM	1221mm stredný element
LL	1097mm element kořcový
MAT	matný difúzor
MPR	mikroprizmatický difúzor
W	farba korpusu: biela
B	farba korpusu: čierna
S	farba korpusu: strieborná
NT	prisadená verzia
ALIN +CORD +ROPE	závesná verzia
ALIN +ALIN NT GRIP	nástenná verzia

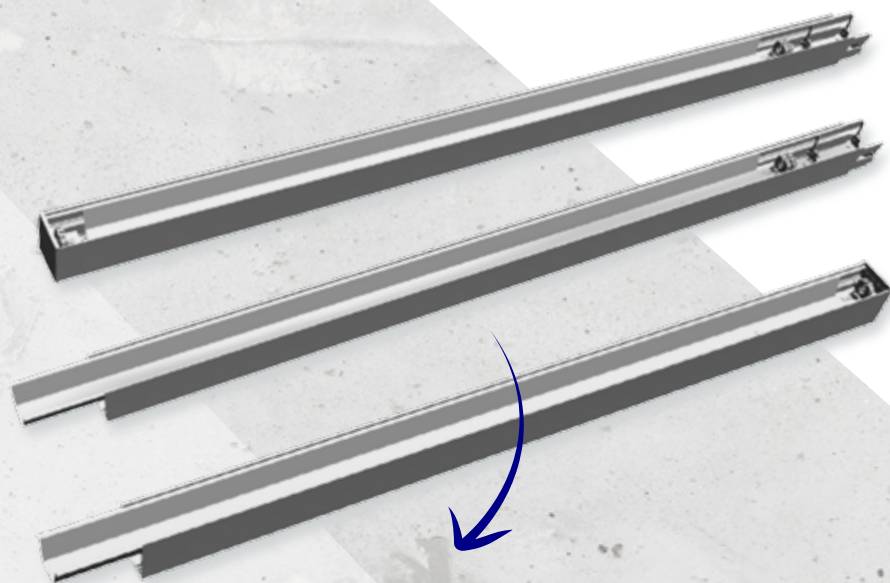

ODPORÚČANÝ SVETELNÝ ZDROJ GLASSV4.

Profesionálne žiarivky v LED technológii sú:

- sklenený korpus
- 3 roky záruka
- svetelná účinnosť do
- IC driver
- vyžarovací uhol 220°
- energetická trieda: C



160LM/W

T8 LED GLASSV4
18W-NW [33212]

T8 LED GLASSV4
18W-CW [33213]

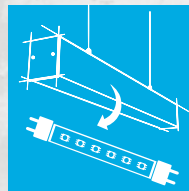

lína LF

lína LM

lína LL

KANLUX ALIN 4LED LINE

VÝZNAM PÍSMEN V NÁZVE

LF4LED120-MAT-B-NT

element línie
4LED

difúzor

farba
korpusu

spôsob
montáže

LF

33788 LF 4LED 120-MAT-B
33789 LF 4LED 120-MAT-B-NT
33790 LF 4LED 120-MAT-SR
33791 LF 4LED 120-MAT-SR-NT
33792 LF 4LED 120-MAT-W
33793 LF 4LED 120-MAT-W-NT
33770 LF 4LED 120-MPR-B
33771 LF 4LED 120-MPR-B-NT
33772 LF 4LED 120-MPR-SR
33773 LF 4LED 120-MPR-SR-NT
33774 LF 4LED 120-MPR-W
33775 LF 4LED 120-MPR-W-NT

LL

33800 LL 4LED 120-MAT-B
33801 LL 4LED 120-MAT-B-NT
33802 LL 4LED 120-MAT-SR
33803 LL 4LED 120-MAT-SR-NT
33804 LL 4LED 120-MAT-W
33805 LL 4LED 120-MAT-W-NT
33782 LL 4LED 120-MPR-B
33783 LL 4LED 120-MPR-B-NT
33784 LL 4LED 120-MPR-SR
33785 LL 4LED 120-MPR-SR-NT
33786 LL 4LED 120-MPR-W
33787 LL 4LED 120-MPR-W-NT

LM

33794 LM 4LED 120-MAT-B
33795 LM 4LED 120-MAT-B-NT
33796 LM 4LED 120-MAT-SR
33797 LM 4LED 120-MAT-SR-NT
33798 LM 4LED 120-MAT-W
33799 LM 4LED 120-MAT-W-NT
33776 LM 4LED 120-MPR-B
33777 LM 4LED 120-MPR-B-NT
33778 LM 4LED 120-MPR-SR
33779 LM 4LED 120-MPR-SR-NT
33780 LM 4LED 120-MPR-W
33781 LM 4LED 120-MPR-W-NT

PRÍSLUŠENSTVO

Napájacie káble k svietidlám a líniam ALIN,
1 fázové, čierne/ strieborné/ biele 150 cm

32541 ALIN CORD 1F-B

32542 ALIN CORD 1F-SR

32542 ALIN CORD 1F-W

Držiak na stenu pre svietidlo ALIN,
2 ks v balení

29557 ALIN NT GRIP

Ocelové lanko (samostatné) pre zavesenie
svietidiel, 2 ks v balení

07871 ROPE-NT 150 SINGLE

Kanlux

TX
ALIN
LINE

Kanlux
FACTORY

kanlux.com

Kanlux

WSPARCIE TECHNICZNE

+48 /32/ 388 74 60

@: techniczne@kanlux.pl



Kanlux
F△FACTORY

kanlux.com